

1. Description:.....	1
2. Specifications.....	2
3. Dimensional outline.....	2
4. Electrical specifications.....	3
5. Description of functions.....	5
Charging stages and supported chemistries:	5
Field reduction:	6
Warning condition:	6
Fault condition:.....	6
SLAVE regulation mode:.....	6
Current Measurements:.....	6
6. USB interface.....	7
Regulator Settings:.....	7
System State and Peer System State:	12
Memo Field:.....	13
7. NMEA-2000 interface.....	14
8. Wi-Fi interface.....	15
9. Installation:	18
10. Reference Connection diagrams	23
Connection with 2 Engines:.....	23
Single Engine (Showing 2 nd Alternator option).....	24
System with Remote Rectifier	25

1. Description:

The E-MAAX PRO X continues the development program of the previous E-MAAX models, with enhancements driven by customer feedback and the industry standard for NMEA connectivity.

The E-MAAX PRO X has several iterations as the development is a continual process. This manual refers to version 7 with the following enhancements and identifiers;

- External USB connection (adjacent to NEMA connector)
- Auto tuning (elimination of internal adjustment pots)
- Tunable output to RPM

E-MAAX PRO X V7 Regulator optimizes alternator output based on;

- System load
- Battery type
- Current and voltage sensing
- Engine RPM

The battery charging profile is programmed based of battery type for the common batteries (Lead Acid / AGM / Gel / FireFly / Custom-LiFePO₄ / "LiFePO₄ MAAX") in both 12 and 24 Volt and "P" or "N" alternator configurations. The PRO X has two LED's which function as visual status indicators and fault diagnostics.



2. Specifications

Parameter	Value	Units
Weight	200	grams
Housing material	Polypropylene	-
Operating range	-20 .. +100	Celsius deg
Protection	IP 56	-
Maximum allowable shock	3	G
Maximum allowable relative humidity	95	%

3. Dimensional outline

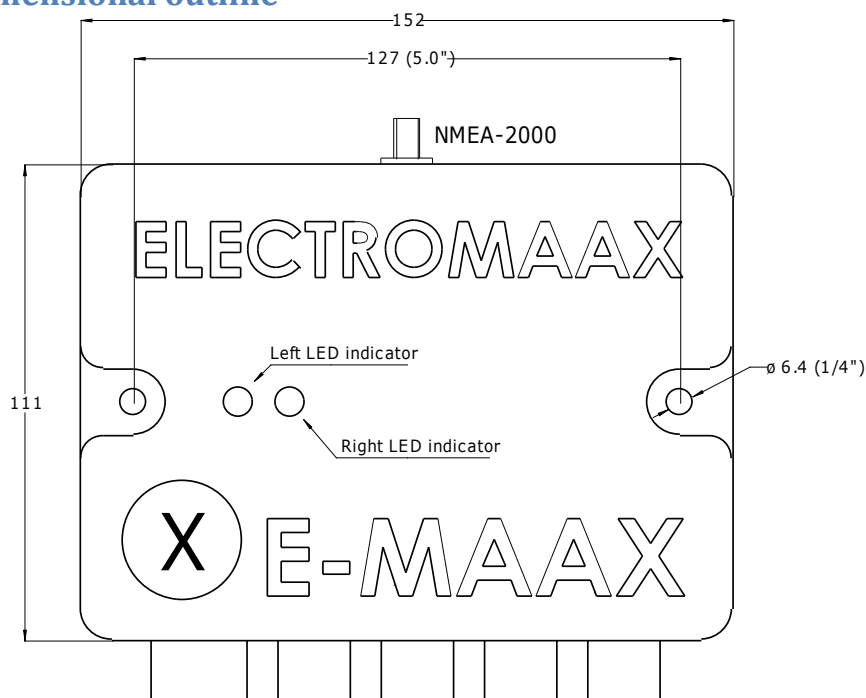

All units are millimeters (inches)

4. Electrical specifications

Parameter	Value	Units
Maximum operating supply voltage	40	Volts
Current consumption	Up to 0.150	Amps
Maximum operating Field current	20	Amps
Maximum operating voltage at Battery Voltage Sensor leads	40	Volts
Maximum operating voltage at Alternator Current Shunt leads	40	Volts
Maximum operating voltage at Battery Current Shunt leads	5	Volts
Power Cable ratings	Gauge: 14 AWG Material: tinned copper strands Insulator Material: PVC Jacket Color: black Diameter: 13 mm Insulation: up to 300 Volts	-
Signal and Sensing Leads ratings	Gauge: 18 AWG Material: tinned copper strands Insulator Material: PVC Insulation: up to 300 Volts	-

Refer to the connectors diagram below for additional connection information on cables. The diagram shows a regulator view from the connectors side.

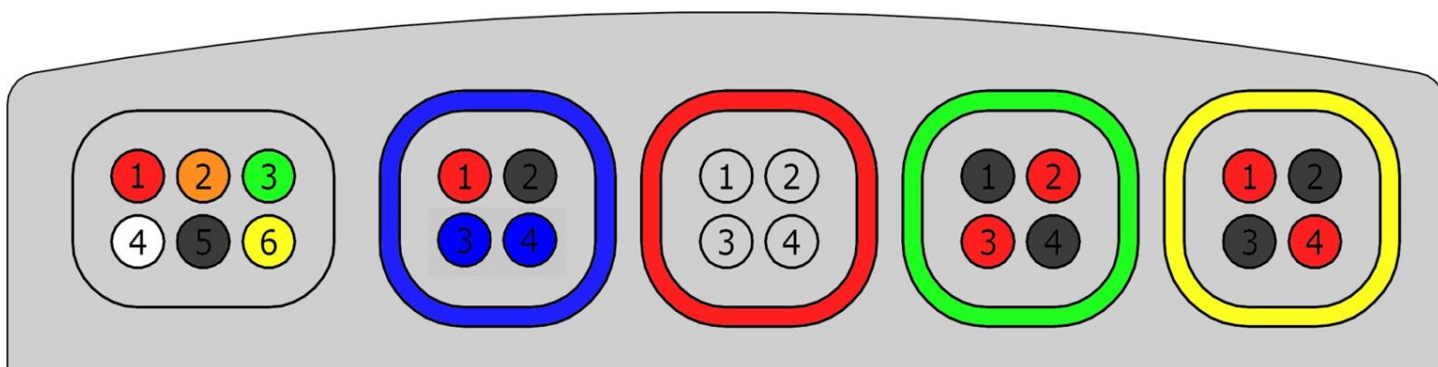

Cable	Color Code	Pin	Pin Color	Function	Connects to
Power Harness	None	1	Red	Battery Positive	B+ post of the alternator
		2	Brown	Field Output #1	F post of the alternator
		3	Green	Field Output #2	F post of the secondary alternator
		4	White	Ignition Input	Ignition source
		5	Black	Battery Ground	case of the alternator
		6	Yellow	Tachometer Input	W post of the alternator
Alternator Temperature sensing	Blue	1	Red	Temperature Sensing	case of the alternator
		2	Black		
		3	Blue	Field Reduction Switch	Customer Supplied Switch (NO) - Optional
		4	Blue		
Regulator-to-regulator communication	Red	1	-	OUT-	"IN-" at another Pro X
		2	-	OUT+	"IN+" at another Pro X
		3	-	IN+	"OUT+" at another Pro X
		4	-	IN-	"OUT-" at another Pro X
Battery Voltage and Temperature sensing	Green	1	Black	Temperature Sensing	Sensor to either battery post
		2	Red		
		3	Red	Voltage sensing	B+ post of the battery
		4	Black		B- post of the battery
Battery and Alternator Current sensing	Yellow	1	Red	H lead	Battery Current Shunt
		2	Black	L lead	Battery Current Shunt
		3	Black	L lead	Alternator Current Shunt
		4	Red	H lead	Alternator Current Shunt

Notes:

- **Battery leads are 3M in length and Alternator leads are 2M in length.**
- **If shunt is customer supplied ensure the voltage at the Battery Current Shunt leads, H and L, is NOT greater then 5V in respect to the Battery Ground.**
- **Make sure the harness color codes match that of the regulator connectors.**

Diagram of one shoulder of the regulator-to-regulator communication is shown below to illustrate the connection of the communication cable between two PRO X regulators.

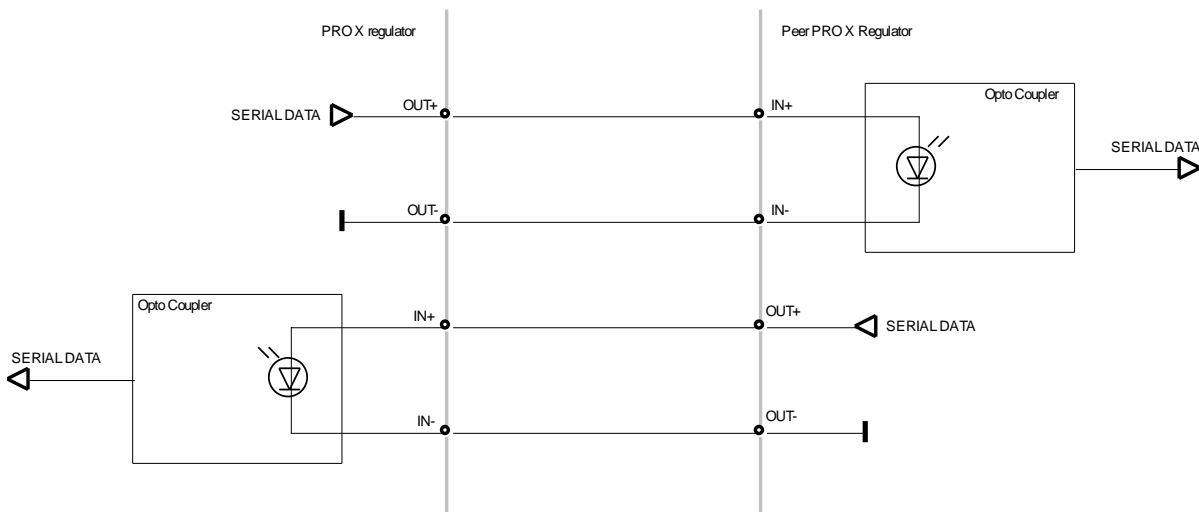



5. Description of functions

The PRO X regulator provides alternator output by controlling the “Field” input into the alternator. As the Field signal is increased or decreased so the alternator output follows. The term Field Output refers to Field condition from the Regulator, whereas Field Input is the same value from the Alternator’s perspective.







Visual Indication

PRO X Regulator has two LED indicators.

Left indicator works only when the ignition is inactive and there is no regulation.

Lighting sequence	Meaning
	Regulator is powered up, ignition is switched off. It flashes green every 1 seconds.
	Regulator is busy reporting its settings to external PC
	Regulator is busy updating its settings from external PC

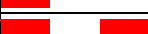
Right indicator works only when the ignition is active and there is regulation.

Lighting sequence	Meaning
	Warm-up stage of regulation
	Bulk+Absorb stage of regulation
	Float stage of regulation
	Warning or Reduced Field condition
	Critical Fault condition , when regulator disables the alternator’s output
	SLAVE mode of regulation

Supported Optional Peripherals:

PRO X Regulator supports any of the following peripherals:

- Alternator Temperature Sensor
- Battery Temperature Sensor
- Alternator Current Measurement Shunt
- Battery Current Measurement Shunt
- Battery Voltage Sensor

The peripherals can be hot-plugged at any time without restarting the regulator. The regulator detects the presence of any compatible peripheral and acquires data from it automatically.

Charging stages and supported chemistries:

X Regulator supports the following battery chemistries, in both 12 and 24 Volts:

- Lead-acid
- AGM
- Gel
- Carbon Foam
- Lithium MAAX LiFePO4
- Lithium
- 2 custom profiles

Upon the activation of the Ignition lead, the PRO X Regulator regulates the battery charge through the following charge profile stages:

- Warm-up
- Bulk + Absorb
- Float

Depending on the charging conditions, such as immediate load requirements and engine speed, the PRO X Regulator switches between the charge profile stages to achieve the optimal charging.

Field reduction:

When connected to the PRO X regulator via Wi-Fi, the webpage allows reduction of the regulator’s Field Output to divert engine power from generating electricity to the propellers if needed. Each screen button press reduces Field Output in 10% increments, down to 30% of its nominal value for the current charging conditions. Field reduction is indicated by the right LED flashing red once and is re-set automatically when the ignition is switched off.

An alternative method of obtaining 50% output reduction is installing a customer supplied switch (NO) connected to the blue wires available with the alternator temperature sensor harness.

Warning condition:

Warning condition is a special mode of regulation when the Field Outputs are reduced to 50% of their nominal value for the current charging conditions. The regulator is placed into the Warning condition due to one or more of the following conditions:

- a) Elevated battery’s temperature
- b) Elevated alternator’s temperature
- c) Elevated battery’s voltage
- d) Voltage Drop in cabling is too large

The Warning condition is indicated by the right LED flashing red once. Warning condition is re-set automatically when the ignition is switched off.

Fault condition:

Fault condition is an alarm mode (right LED flashing red two times quickly) when Field output is disabled in order to avoid damage to the charging system. The regulator is placed into the Fault condition due to one or more of the following conditions:

- a) The regulator’s temperature reaches 70°C
- b) Internal regulator hardware malfunction
- c) The battery’s temperature exceeds its maximum allowed value
- d) The battery’s voltage exceeds its maximum allowed value
- e) The alternator’s temperature its maximum allowed value

Critical Fault condition does not require restart of the regulator; it is re-set automatically when the fault condition is cleared.

SLAVE regulation mode:

In a 2 regulator system where the regulators are connected via a communication cable (optional); one regulator will act as a MASTER and the 2nd as a SLAVE, this peer state can be viewed in both USB and WiFi interface. SLAVE is a fail-safe mode of regulation when the Pro X regulator is being supervised by another Pro X regulator on another engine. 4-wire communication connection is required between the two Pro X regulators installed on two engines charging same battery. This mode is indicated with one short blue flash of the right LED.

Current Measurements:

After having established the required connection to the battery and alternator shunts, the regulator must be adjusted to zero the current measurement. This is due to the resistivity of the wiring elements the current measurement shunts are connected with.

To calibrate the alternator leads, the “Calibrate Alternator Current Lead” menu command must be invoked in “resting” state.

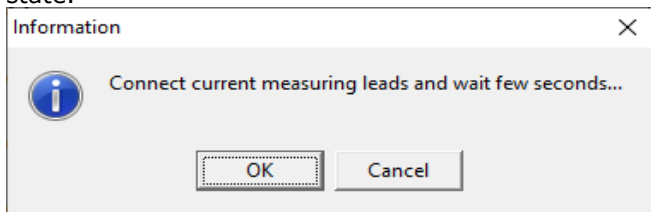

6. USB interface

USB interface is provided for full access to the device's parameters. It connects to a PC via the **EmX.exe** application. The application is available to download from the ElectroMaax website www.electromaaxsupport.com/EmX7.zip System State, as well as the Peer System State (Peer System is another X regulator which is connected to the one where USB interface is being used), is refreshed each half second to provide monitoring and troubleshooting capabilities during the system install and commissioning.

Regulator Settings:

With the application it is possible to view and modify the device's settings to suit a particular installation.

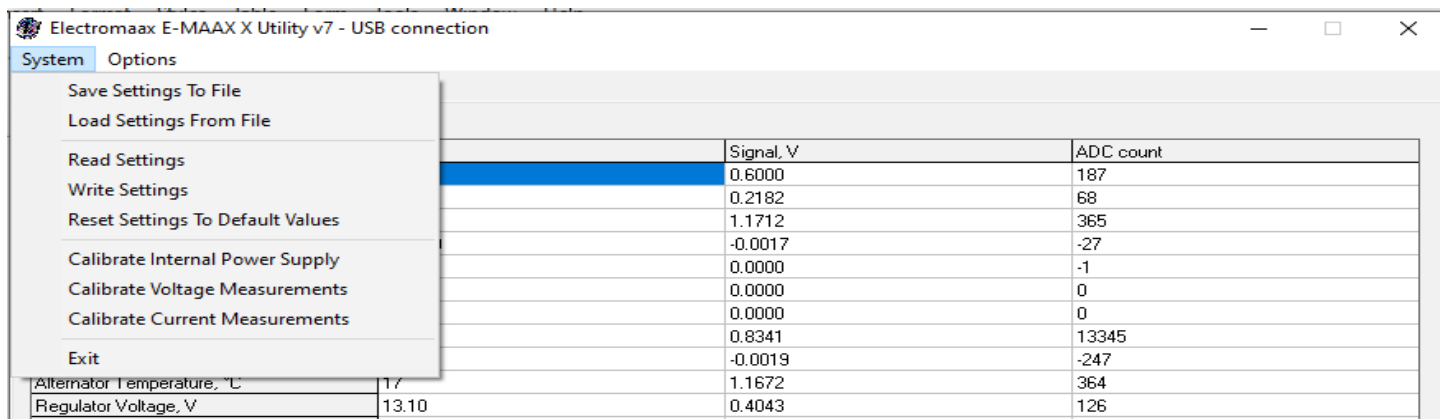

	Signal, V	ADC count
	0.6000	187
	0.2182	68
	1.1712	365
	-0.0017	-27
	0.0000	-1
	0.0000	0
	0.0000	0
	0.8341	13345
	-0.0019	-247
Alternator Temperature, °C	1.1672	364
Regulator Voltage, V	0.4043	126

"Save Setting To File" stores the screen values to a file.

"Load Setting From File" brings to the screen settings stored in a file.

"Read Settings" brings to the screen actual stored settings from the connected Pro X regulator.

"Write Settings" stores the screen values to the connected Pro X regulator. Ignition must be off.

"Reset Settings to Default Values" makes the connected Pro X regulator revert to the factory settings. Ignition must be off.

Electromaax E-MAAX X Utility v7 - USB connection

System Options

System State: Settings

Device Version	7
Device Name	X Regulator
Warning Battery Temperature, °C	40
Fault Battery Temperature, °C	50
Warning Battery Voltage, V	15.00
Fault Battery Voltage, V	16.00
Warning Alternator Temperature, °C	100
Fault Alternator Temperature, °C	110
Crank-To-Alternator Pulley Ratio [1..10]	2.540
Alternator Poles [6..32]	12
Wi-Fi Mode [0-off, 1-STA, 2-AP]	2
Wi-Fi SSID	E-MAAX X
Wi-Fi STA Password	
Wi-Fi AP IP address	192.168.0.1
Support Host Domain	electromaaxsupport.com
CAN Bus Mode [0-off, 1-NMEA2000]	0
Claimed NMEA-2000 Address	99
Active Charge Profile Number [0..7]	0 - FLA
Allowed Voltage Drop in Wiring, V	1.000
Battery Shunt Resistance, Ohm	0.000100
Alternator Shunt Resistance, Ohm	0.000100
Alternator Type [1-P, 2-N]	1
Regulation Climb Coefficient, V/s	2.500
Regulation Collapse Coefficient, V/s	200.000
Regulation Band, V	0.100
Regulation Refresh Rate, Hz	20
Field/RPM [x-Curve, 0-Off, nnn-Threshold]	0
Comparator Voltage Comp	0.987738
Battery Plus Voltage Comp	1.009035
Battery Minus Voltage Comp	1.009035
Power Supply Voltage Comp	1.011348
Regulator Voltage Comp	1.012539
Battery Shunt Bias	0.000009
Alternator Shunt Voltage Gain #1	15.709580
Alternator Shunt Voltage Gain #2	15.746892
Aux Temp Sensor Usage [0-Battery, 1-Alt]	1

0 - FLA | 1 - AGM | 2 - GEL | 3 - FireFly | 4 - LiFePO4 | 5 - Custom

Warm-up Duration, s	1
Warm-up Target Voltage, V	14.10
Warm-up Minimum Field, %	15
Warm-up Maximum Field, %	49
Bulk Target Voltage, V	14.50
Bulk Limit Voltage, V	14.80
Bulk Minimum Field, %	15
Bulk Maximum Field, %	99
Float Target Voltage, V	13.30
Float Leave Voltage, V	13.00
Float Minimum Field, %	5
Float Maximum Field, %	15

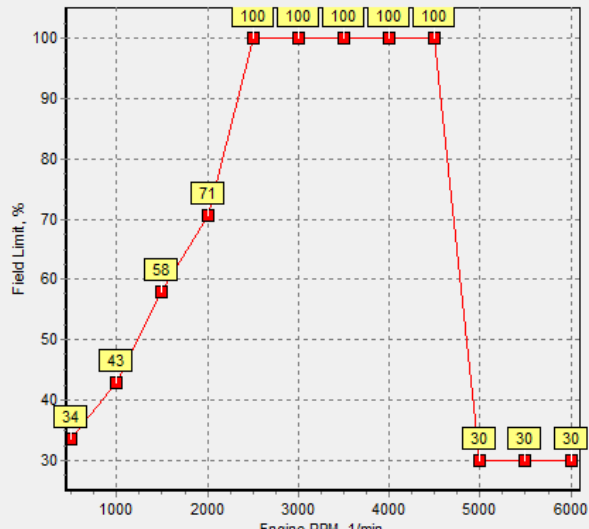

65 bytes received

Refer to the table below for the description of the available settings

Parameter	Meaning	Valid Range	Units
Device Version	Firmware version, set at the factory	-	-
Device Name	String up to 16 characters long to identify the X regulator on webpage and when there are 2 X regulators in the system.	-	-
Warning Battery Temperature	House Battery temperature above which the alternator's output is limited to 50% to avoid overheating. Set to 0 if the feature is not used.	30-50	°C
Fault Battery Temperature	House Battery temperature above which the alternator's output is cut to avoid overheating. Set to 0 if the feature is not used.	40-60	°C
Warning Battery Voltage	System voltage above which the alternator's output is limited to 50%. Set to 0 if the feature is not used.	10-30	Volts
Fault Battery Voltage	System voltage above which the alternator's output is cut. Set to 0 if the feature is not used.	10-30	Volts

Warning Alternator Temperature	Alternator temperature above which the alternator's output is limited to 50% to avoid overheating. Set to 0 if the feature is not used. The feature works only when the Alternator Temperature sensor is connected to the regulator.	70-100	°C
Fault Alternator Temperature	Alternator temperature above which the alternator's output is cut to avoid overheating. Set to 0 if the feature is not used. The feature works only when the Alternator Temperature sensor is connected to the regulator.	70-110	°C
Crank-to-Alternator Pulley Ratio	Actual "Crank Pulley Diameter" to "Alternator Pulley Diameter" ratio. This parameter is used to calculate the engine RPM.	1-10	-
Alternator Poles	Number of the poles in the alternator used. Refer to the alternator manufacturer's datasheet. This parameter is used to calculate the engine RPM.	6-30	-
Wi-Fi Mode	0-Wi-Fi module is disabled 1- Wi-Fi module presents as a device in an existing local network, and can be connected to as to a client with a local address, i.e. supports one connection at a time. (Station Mode) 2- Wi-Fi module presents as a server and produces own local network, and can be connected to as to a website with a local address, i.e. supports multiple connections. (Access Point Mode)	0 or 1 or 2	-
Wi-Fi SSID	String up to 32 characters long (alpha-numeric characters only). While in Station Mode, indicates the name of an existing Wi-Fi network to connect to. While in Access Point mode, sets the name of the Wi-Fi network created by the X regulator, so client can connect to it.	-	-
Wi-Fi STA Password	String up to 32 characters long (alpha-numeric characters only). While in Station Mode, indicates the password required to connect to an existing Wi-Fi network. While in Access Point mode connection does not use password.	-	-
Wi-Fi AP IP Address	While in Access Point mode, sets the IP address of the server of the Wi-Fi network created by the X regulator.		
Support Host Domain	Host address used for remote support requests		
CAN Bus Mode	0 – CAN communications are disabled 1- Allows CAN communications for the PRO X regulator when connected to an NMEA-2000 network.	0 or 1	-
Claimed NMEA-200 Address	A number to identify the PRO X regulator on the NMEA-2000 network. Must be a unique number for each PRO X regulator in the system. It may also be displayed as the "Serial Number", or as the "Device Instance"	0-255	-
Active Charge Profile Number	Zero-based index to identify the House Battery chemistry used. 0 – FLA, or Lead-acid 1 - AGM 2 – GEL 3 - Carbon Foam, or FireFly 4 - Lithium MAAX LiFePO4 5 – generic Lithium 6 – custom Profile 7 - custom Profile This parameter is changed by clicking on different profile name tabs of the regulation settings.	0-7	-
Allowed Voltage Drop In Wiring	When the wiring voltage drop exceeds this value, the alternators' output is limited to 50% to avoid equipment damage. Default value is 1.0.	0-2	Volts

Battery Shunt Resistance	Battery Shunt Resistance used to calculate the battery current. Can be derived from the shunt designation. For instance, "50mV/500A" means that the Shunt Resistance is 0.0001. Set to 0 if the feature is not used.	0-0.1	Ohms
Alternator Shunt Resistance	Battery Shunt Resistance used to calculate the battery current. Can be derived from the shunt designation. For instance, "50mV/500A" means that the Shunt Resistance is 0.0001. Set to 0 if the feature is not used.	0-0.1	Ohms
Alternator Type	Set to 1 if a P-type alternator is used; set to 2 if a N-type alternator is used.	1 or 2	-
Regulation Climb Coefficient	This parameters sets the pace at which the regulator tries to achieve the set voltage when the set voltage is greater than the immediate system voltage. Default value = 5	1-100	Volts/sec
Regulation Collapse Coefficient	This parameters sets the pace at which the regulator tries to achieve the set voltage when the set voltage is lesser than the immediate system voltage. Default value = 200	1-400	Volts/sec
Regulation Band	Tolerance to target of the voltage-based regulation. Default=.05	0.01-0.5	Volts
Regulation Refresh Rate	Sets the pace at which the regulator refreshes itself. Default = 40	20-200	Hz
Field / RPM	X- Follows Engine RPM graph Set to 0 is the feature is not used non-zero value RPM below which the alternator's output is limited to 50% to avoid engine stall..	X / 0-1000	Rpm
Comparator Voltage Comp	Calibration of comparator switching threshold – adjusted at factory		
Battery Plus Voltage Comp	Modified by performing "Calibrate Voltage Measurements" in system menu		
Battery Minus Voltage Comp	Modified by performing "Calibrate Voltage Measurements" in system menu		
Power Supply Voltage Comp	Voltage setting of internal supply – adjusted at factory		
Regulator Voltage Comp	Modified by performing "Calibrate Voltage Measurements" in system menu		
Battery Shunt Bias	Modified by performing "Calibrate Current Measurements" in system menu		
Alternator Shunt Voltage Gain #1	Modified by performing "Calibrate Current Measurements" in system menu		
Alternator Shunt Voltage Gain #2	Modified by performing "Calibrate Current Measurements" in system menu		
Aux Temp Sensor Usage	The battery temperature sensor may be used as a second alternator sensor instead. 0-battery 1-alternator	0 or 1	-
Warmup Duration	Time spent in initial warmup stage when output is limited		Volts
Warmup Target Voltage	Voltage during engine warmup stage as per user defined setting value		Volts
Warmup Minimum Field	User defined value	5-99	%
Warmup Maximum Field	User defined value	5-99	%
Bulk Target Voltage	Refer to Battery manufacturer's specification		Volts
Bulk Maximum Limit Voltage	Refer to Battery manufacturer's specification		Volts
Bulk Minimum Field	Minimum field to maintain tachometer output	5 to 50	%
Bulk Maximum Field	Maximum field during Bulk stage	5 to 99	%

Float Target Voltage	Refer to Battery manufacturer's specification		Volts
Float exit Voltage	Voltage that regulator returns to Bulk stage		Volts
Float Minimum Field	Minimum field to maintain tachometer output	5 to 15	%
Float Maximum Field	Maximum field during Float stage	5 to 25	%

System State and Peer System State:

Displayed information is separated into the following groups: Measured Values, System State, Regulator State, and Messages.

Electromaax E-MAAX X Utility v7 - USB connection

System Options

System State | Settings | Peer System State [X Regulator]

Measured Values

Measured Parameter	Value	Signal, V	ADC count
B+ Voltage, V	13.03	0.5996	187
B- Voltage, V	-0.06	0.2180	68
Battery Temperature, °C	19	1.1703	365
Voltage at Battery Shunt, V	-0.3330	-0.0027	-43
Voltage across Battery Shunt, V	0.0000	0.0000	-1
Field #1 Voltage, V	12.88	0.4024	126
Field #2 Voltage, V	12.93	0.4040	126
Voltage at Alternator Shunt, V	13.08	0.8337	13339
Voltage across Alternator Shunt, V	0.0001	-0.0019	-240
Alternator Temperature, °C	17	1.1663	364
Regulator Voltage, V	13.09	0.4040	126
Regulator Temperature, °C	31	1.0116	316
Power Supply Voltage, V	7.54	1.4909	465
Reference Voltage, V	0.003	2.0480	639
Engine RPM, 1/min	2112	536.4637	289

System State

System Parameter	Value
Detected System Voltage, V	12
Battery Voltage, V	13.09
Battery Current, A	0
Alternator Current, A	1
Load Current, A	-1
FRS Value, %	0
Set System Field Limit, %	95
Set Slave Field Limit, %	0
Status Code	0x00000009

Regulator State

Regulator Parameter	Value
Running Time	0:0:6
Status	Bulk
Digital Field Output, %	up to 95
Regulation Target, V	14.20
Set Minimum Field, %	5
Set Maximum Field, %	95
Wiring Voltage Drop, V	0.000

Regulator Name: X Regulator
Ignition Input active
Wi-Fi connected

65 bytes received

Memo Field:

Connection Status' and all warnings and faults. **Review before requesting technical support !**

Measured Values are raw electrical signals measured by the regulator's microcontroller via the harness sensing leads. The Measured Values are shown for the diagnostic purposes. Each Measured Value has 3 numbers associated with it: Value, Signal, and ADC Count.

Signal is the voltage at the corresponding microcontroller's pin; it must be within 0 and 2 Volts.

ADC Count is the result of analog-to-digital conversions. Valid range for ADC Count is between 0 and 2047 (11 bits), except for the Shunt measurements between -32767 and 32767 (16 bits).

Parameter value: such as temperature, voltage, etc.

ADC Count being outside its valid range means a microcontroller fault. Signal outside its range means faulty connections of the sensing leads. Value outside of its range means incorrect installation or charging system faults.

Parameter	Meaning	Units
B+ Voltage	Measured voltage between the "B+" post of the battery and the regulator's ground (the battery voltage sensor MUST be connected).	Volts
B- Voltage	Measured voltage between the "B-" post of the battery and the regulator's ground. (the battery voltage sensor MUST be connected). May be negative due to the voltage drop in wiring.	Volts
Battery Temperature	Measured temperature of the battery	°C
Voltage at Battery Shunt	Voltage at the battery shunt; must be equal to "B- Voltage"	Volts
Voltage across Battery Shunt	Voltage drop across the battery shunt due to the battery current. Can be positive or negative.	Volts
Field #1 Voltage	Voltage on the "F" post of the alternator	Volts
Field #2 Voltage	Voltage on the "F" post of the secondary alternator	Volts
Voltage at Alternator Shunt	Voltage at the Alternator Shunt; must be equal to "Regulator Voltage"	Volts
Voltage across Alternator Shunt	Voltage drop across the alternator shunt due to the charging current. Can be positive.	Volts
Alternator Temperature	Calculated alternator temperature based on the temperature sensor signal.	°C
Regulator Voltage	Voltage at the back of the alternator (measured thru the regulator power harness)	Volts
Regulator Temperature	Temperature inside the regulator's enclosure; should not exceed 60	°C
Power Supply Voltage	Voltage used to power the internal regulator's circuitry; Value to be approximately 7.5 Volts	Volts
Reference Voltage	Voltage used for analog-to-digital conversions; Signal must be 2.048 Volts	Volts
Engine RPM	Calculated engine RPM value based on the measured frequency of the tachometer pulses on the "W" post of the alternator.	rpm

System State parameters are not measured directly, but calculated from the Measured Values or set by the software according to the current operating conditions.

Parameter	Meaning	Units
Detected System Voltage	On power-up, while the X Regulator runs self-diagnostic and start-up procedures for a few seconds, it also auto-detects the system voltage and adjusts the regulation parameters to it. Possible values are 12, 24, or 0 (not detected).	Volts
Battery Voltage	If the voltage sensing harness is connected, the parameter is the difference between the "B+ Voltage" and the "B- Voltage" measured values on the battery, otherwise it is the <i>Regulator Voltage</i>	Volts
Battery Current	Value calculated from the "Battery Shunt Voltage Drop" and the "Battery	Amps

	Shunt Resistance" parameters	
Alternator Current	Value calculated from the "Alternator Shunt Voltage Drop" and the "Alternator Shunt Resistance" parameters	Amps
Load Current	Difference between the "Battery Current" and the "Alternator Current" parameters.	Amps
FRS Value	Field Reduction Switch value set to limit the alternator output	%
Set System Field Limit	Limitation of the alternator output due to immediate operating conditions.	%
Set Slave Field Limit	Limitation of the alternator output when there are two X regulators in the system and the given regulator acts as a "Slave".	%
Status Code	Internal system status	

Regulator State parameters are dynamically calculated values according to the current operating conditions.

Parameter	Meaning	Units
Running Time	Accumulated time in the present charging stage.	-
Status	Regulation State – monitoring / charging	-
Digital Field Output	Set alternator output	%
Regulation Target	Set target Battery voltage	Volts
Set Minimum Field	Lower limit of field output	%
Set Maximum Field	Upper limit of field output	%
Wiring Voltage Drop	Measured voltage drop to batteries from alternator	Volts

7. NMEA-2000 interface

PRO X Regulators can be connected to an existing NMEA-2000 network allowing current regulator status to be displayed on the vessel's displays.

Network credentials are as following:

- NMEA2000 VID = 1127 decimal or 0x0467 hex
- NMEA2000 PID = 25936 decimal or 0x6550 hex
- NMEA2000 Product Name = Electromaax X
- NMEA2000 Function Code = 141
- NMEA2000 Class Code = 35
- NMEA2000 Software Version = 1.0
- NMEA2000 Standard = 3.101

The X regulator reports the state of the "DC Sources" such as:

- a) "DC source #0" shows the following values:
 - Alternator Voltage
 - Alternator Temperature
 - Engine RPM
- b) "DC Source #1" shows the following values from another X regulator connected to the given X regulator:
 - Peer Alternator Voltage
 - Peer Alternator Temperature
 - Peer Engine RPM
- c) "DC Source #2" shows the following values:
 - Alternator Current
 - Peer Alternator Current
 - Battery Current
 - Load Current
 - Load Voltage

- Battery Temperature
- Battery Voltage

The following PGNs are transmitted over the network:

- PGN127506()
- PGN127508()
- PGN127751()

EMx.exe allows monitoring the raw CAN network frames when the NMEA-2000 network is connected and enabled in the device settings.

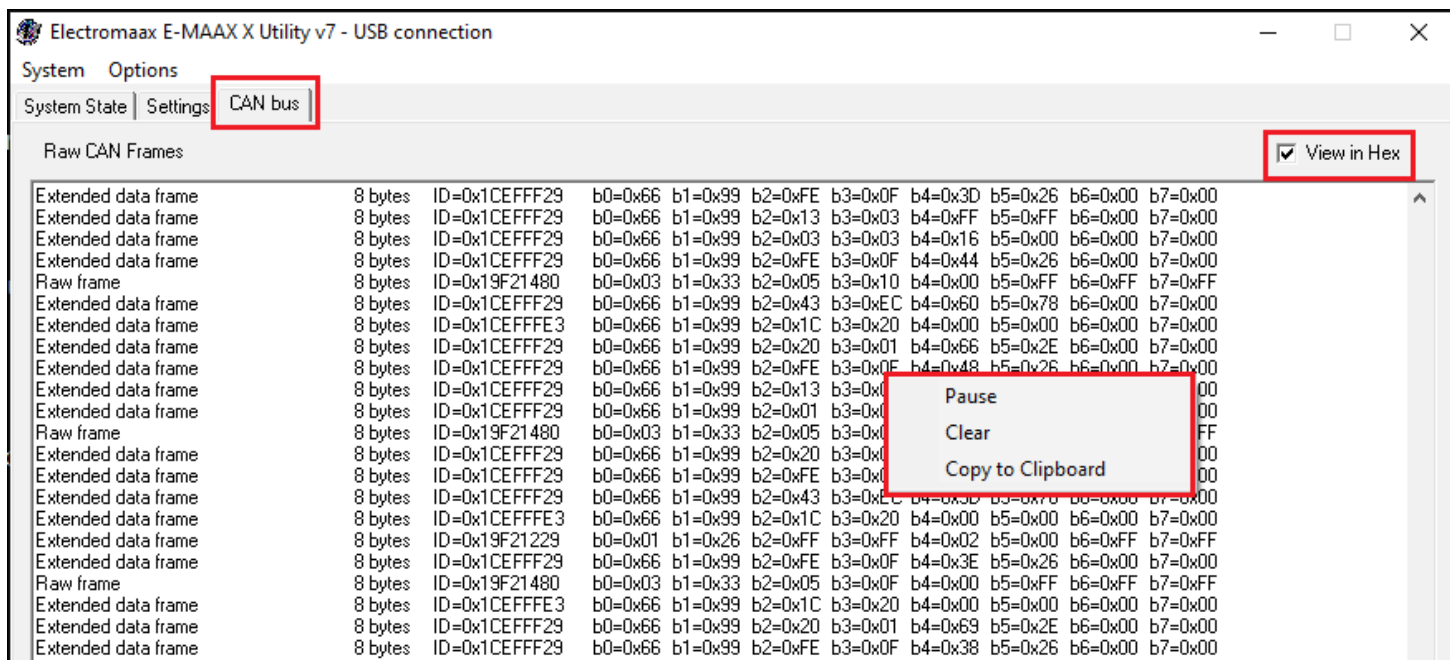

Selecting **CAN bus** tab shows network activity; right mouse click brings up Pause / Clear / Copy menu

8. Wi-Fi interface

When using the PRO X regulator Wi-Fi in Access Point Mode (the “Wi-Fi Mode” parameter is set to 2), the PRO X regulator creates its own wireless network, and acts as a dynamic server on it. SSID of the network is set as the value of the “Wi-Fi SSID” parameter. Access Point Mode does not require any passwords to connect to it. The local IP address of the server is set as the value of the “Wi-Fi AP IP Address” parameter. Password is not used to connect in Access Point mode.

In order to connect to it, users run an internet browser on any platform, and type the local IP address in the address bar.

When using the PRO X regulator Wi-Fi in Station Mode (the “Wi-Fi Mode” parameter is set to 1), the PRO X regulator connects to an existing wireless network as a device, and acts as a dynamic server on it. The “Wi-Fi SSID” and “Wi-Fi STA Password” parameters must be set according to the wireless network’s settings.

The local IP address of the PRO X regulator’s web server is set by the host network it is connected to. The “Wi-Fi AP IP Address” parameter has no meaning in the Station Mode. The network router would show the local IP address of the X regulator under the value of the “Device Name” parameter.

The PRO X Regulator tries to connect to an existing network for 10 seconds. If the connection was not successful, it defaults to the Access Point Mode with the network SSID "EMAAX-X" and no password. Local IP address is set to "192.168.0.1". This is to allow the users to revise the connection settings and try to connect again.

Remote Support is an option when users can allow the system state and settings to be viewed and modified remotely via Internet by the system supplier. This only works when the PRO X Regulator is connected in the Station Mode to a local wireless network with Internet access. Typical example of use would be a cell phone with a Wi-Fi HotSpot and cell data enabled at the same time.

Table below shows the parameters of the Wi-Fi transceiver of the PRO X regulators:

Parameter	Value	Units
Center frequency range	2412 .. 2484	MHz
Wi-Fi wireless standard	IEEE 802.11b/g	-
Data rate at 20MHz 11b	1, 2, 5.5, 11	Mbps
Data rate at 20MHz 11g	6, 9, 12, 18, 24, 36, 48, 54	Mbps
Antenna type	PCB trace antenna	-
TX Power 11b at 1 Mbps	19.5	dBm
TX Power 11b, 11 Mbps	19.5	dBm
TX Power 11g, 6 Mbps	18	dBm
TX Power 11g, 54 Mbps	14	dBm

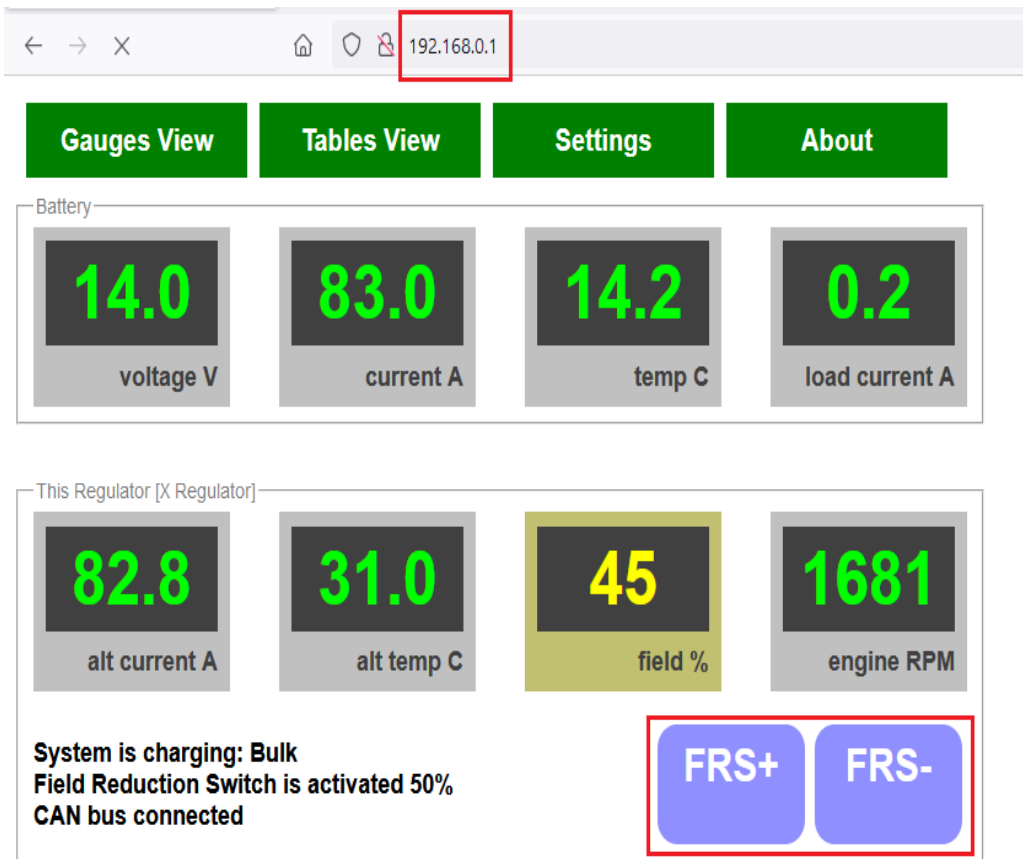

← → X 192.168.0.1

Gauges View Tables View Settings About

Battery

14.0 voltage V **83.0** current A **14.2** temp C **0.2** load current A

This Regulator [X Regulator]

82.8 alt current A **31.0** alt temp C **45** field % **1681** engine RPM

System is charging: Bulk
Field Reduction Switch is activated 50%
CAN bus connected

FRS+ FRS-

In order to view the information on the regulator’s website, users run a Web Browser on any platform, and type the local IP address in the address bar. When a gauge is grayed out, it means that there is no corresponding input. Field Reduction Switch buttons “FRS+” and “FRS-” appear when the PRO X regulator is in charging mode. Remote Support is enabled by clicking “Share Data with Support” button in the “About” section of the website.

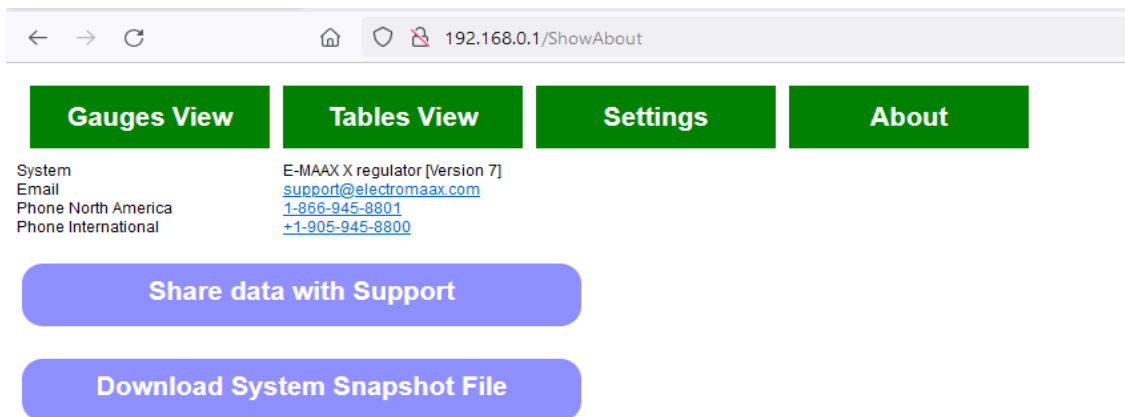

Setting	Meaning
Wi-Fi Mode	0 - Wi-Fi is disabled; 1 - Station mode; 2 - Access Point mode; Note: Regulator must be in WiFi Station Mode to be able to share data with Support
Wi-Fi SSID	Name of the local Wi-Fi network to connect to while in Station mode; Name of the local Wi-Fi network in Access Point mode (up to 32 characters)
Wi-Fi Password	Password for the local Wi-Fi network to connect to while in Station mode (up to 32 characters); there no password required in Access Point mode
Use CAN bus	Set to 1 to enable NMEA-2000 data exchange, or set to 2 to enable CAN communications; If set to zero, communications are disabled
Charging Profile Index	Zero-based index to identify the House Battery chemistry used. 0 - FLA; 1 - AGM; 2 - GEL; 3 - Carbon Foam or FireFly; 4 - Lithium MAAx LiFePO4; 5 - generic Lithium; 6 or 7 - custom Profile;
Battery Fault Temperature	Battery temperature above which the alternator output is cut to avoid overheating. Set to 0 is the feature is not used.
Battery Fault Voltage	System voltage above which the alternator output is cut. Set to 0 is the feature is not used.
Alternator Fault Temperature	Alternator temperature above which the alternator output is cut to avoid overheating. Set to 0 is the feature is not used.
Warm-up Duration	Duration of the warm-up stage of the regulation. Set according to the power of the engine-alternator arrangement.
Maximum Allowed Wiring Voltage Drop	When the wiring voltage exceeds this value, the alternators output is limited to 50% to avoid equipment damage. Default value is 1.0

Shown above is the “**About**” page which provides connection to ElectroMaax Technical Support; if support is not available the system information can be saved as a Snapshot file that can be sent to technical support for review. The snapshot shows system state values at the instant it is created. You can view the Snapshot from the web interface by dragging/dropping the file onto the Windows software. A running log may also be created by selecting “Enable Data Logging to File” in the Windows software.

9. Installation:

Note: A computer running Microsoft Windows is required to perform installation.
Refer to the wiring diagrams at the end of the manual for proper installation.

IMPORTANT: Ensure that your alternator has a sufficient ground. Refer to your alternator installation guide.

1. Connect the six conductor power harness to the regulator (do not attach other connectors at this time)



2. Connect the RED wire of the power harness to the B+ post of your alternator.
3. Connect the BLACK wire to the alternator ground.
4. Connect the BROWN wire to the field post on the alternator.
5. Confirm the ignition is off and connect the WHITE wire to your ignition source (a 24V system may use a 12V or 24V ignition source)
6. Connect the YELLOW wire to the tach (W) output of your alternator. This wire has a splitter to also allow connection to your tachometer.

Note: There is also an additional optional GREEN wire. This connects to the field post of a second alternator when two identical alternators are mounted on the same engine only.

7. Confirm at this point that the left LED indicator is flashing green or verify your connections and check harness fuse and battery/ground connection to alternator.



- Start the "EmX7.exe" application provided on the flash drive on your computer and connect to the regulator with the included USB cable.

Note: the latest software version is also available for download at:
www.electromaaxsupport.com/EmX7.exe or zip file at
www.electromaaxsupport.com/EmX7.zip
 version 7 software only works with version 7 regulators

Observe the USB connection status in the bottom left corner of the application:

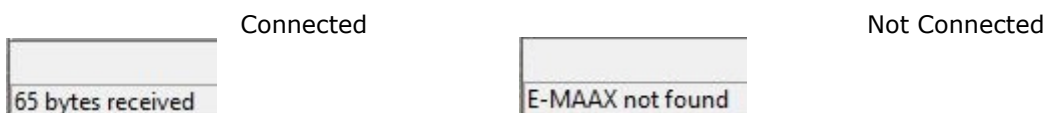

- Click on the "System State" tab near the top and verify that the regulator has detected your correct system voltage and that the regulator status shows as "Monitoring"

System State		Regulator State	
System Parameter	Value	Regulator Parameter	Value
Detected System Voltage, V	12	Running Time	0:0:0
Battery Voltage, V	12.93	Status	Monitoring
Battery Current, A	-2	Digital Field Output, %	up to 95
Alternator Current, A	0	Regulation Target, V	0.00
Load Current, A	-2	Set Minimum Field, %	0
FRS Value, %	0	Set Maximum Field, %	0
Set System Field Limit, %	95	Wiring Voltage Drop, V	0.000
Set Slave Field Limit, %	0		
Status Code	0x00049208		

- Turn on your ignition and verify that the regulator status switches from "Monitoring" to "Warm-up" and that there is a voltage measured on the field, then turn off the ignition.

Regulator State		Measured Values	
Regulator Parameter	Value	Measured Parameter	Value
Running Time	0:0:2	B+ Voltage, V	0.44
Status	Warm-up	B- Voltage, V	0.44
Digital Field Output, %	up to 25	Battery Temperature, °C	0
Regulation Target, V	13.90	Battery Shunt Voltage, V	-0.2339
Set Minimum Field, %	5	Battery Shunt Current, A	0
Set Maximum Field, %	25	Field #1 Voltage, V	6.99
Wiring Voltage Drop, V	0.000	Field #2 Voltage, V	6.99
		Alternator Shunt Voltage, V	0.00

- Mount the alternator temperature sensor to a suitable location on the alternator and connect it to the regulator at the connector marked with the BLUE dot. This connector also includes two short, unconnected wires you can use to connect to a normally open switch (customer supplied) to quickly activate field reduction.
- Connect the battery voltage and temperature sensor to your batteries. Temperature sensor to either post, red terminal to B+ black terminal to B-. Then, connect it to the connector marked with the GREEN dot on the regulator. In a two regulator system, both regulators need their own battery sensor harness.
- Install the shunts according to the wiring diagram then connect the cables to the shunt connectors as shown in the diagram, observing polarity.

A two regulator system requires three shunts instead of two. One for each alternator and one shared for the battery (battery shunt cable from each regulator into one shunt). The shunt below has 4 signal connection terminals; a 2 regulator system will have a signal connection to each regulator. (1 connection shown)

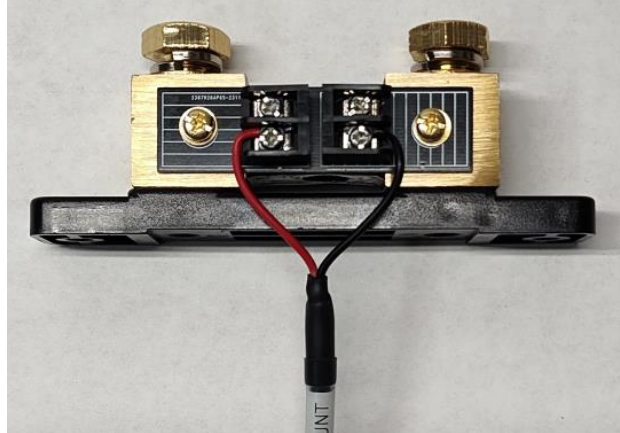

IMPORTANT: There are two cables on the current shunt harness, one is 2 metres long, one is three metres. The battery shunt cable (3m) MUST only connect to the battery shunt.

Connect the current sensor harness to the regulator connector marked with the YELLOW dot.

14. Calibration

Click "System -> Read Settings" first.

In the application "System" menu, there are three calibration items. These are performed with the system at a rest state (no current) and with no loads to be able to properly determine a reference point.

Calibration 1: Not required.

"Calibrate Internal Power Supply" – this is done in the factory and will only need to be redone if you overwrite the value already in place. It requires removal of the cover and measurement of the internal voltage on the VREG test point.

Calibration 2: Required

"Calibrate Voltage Measurements" – measure the voltage at the back of the alternator (B+ <-> GND) with a meter and select this menu item, allow it to update settings.

Calibration 3: Required

"Calibrate Current Measurements" – select this menu item and allow it to update settings.

15. Changing settings

Settings can only be written with ignition signal OFF

Always select "System -> Read Settings"
Then make your changes by editing the value
Then select "System -> Write Settings"

Default settings are already programmed on the regulator, but you must at minimum program your correct battery type by selecting the associated tab and writing the change. Appropriate voltage set points can be

obtained from the battery manufacturer. You will also want to adjust the "Crank to Alternator Pulley Ratio" setting for correct tach reading.
Crank pulley diameter / Alternator pulley diameter = ratio

It is recommended that once you've made all your changes, you save a copy of your settings to a file.
"System -> Save Settings to File"

Additional Info:

Special Volvo power harness -

If you have the Volvo harness you must have the field curve feature enabled – set "Field/RPM" setting to X and set appropriate values for minimum field (default 15%) and adjust the field/RPM graph as necessary. The adjustable field curve allows you to limit the load placed on the engine at lower RPM. This field curve feature can also be used with the standard harness but its use is required for the volvo harness.

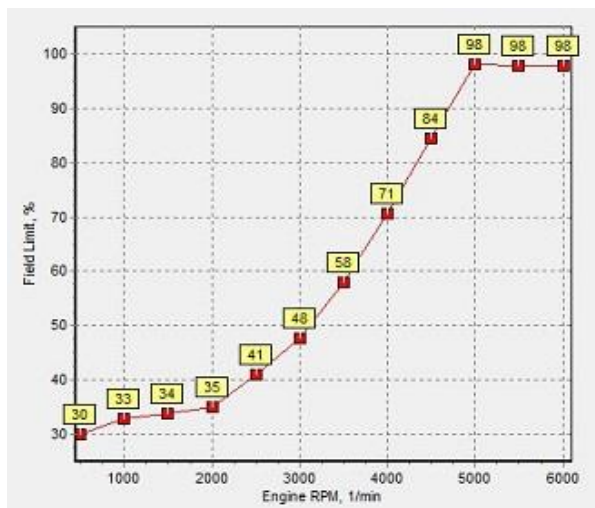

If you are using a 12V tach, but a 24V alternator – you will need to reduce the tach signal output from the alternator. Below is an example of a voltage divider using resistors with 24V tach input and 12V tach output..

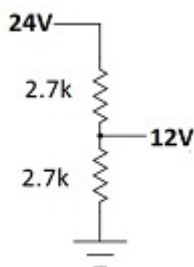

In a two regulator system, once each regulator is verified to work independently, attach the communication cable to both regulators at the connectors marked with the RED dot. You will then see the third tab appear in the software interface.



This allows you to view the system state of both regulators. Settings, however, can only be altered on the device currently connected via USB.

10. Reference Connection diagrams

Connection with 2 Engines:

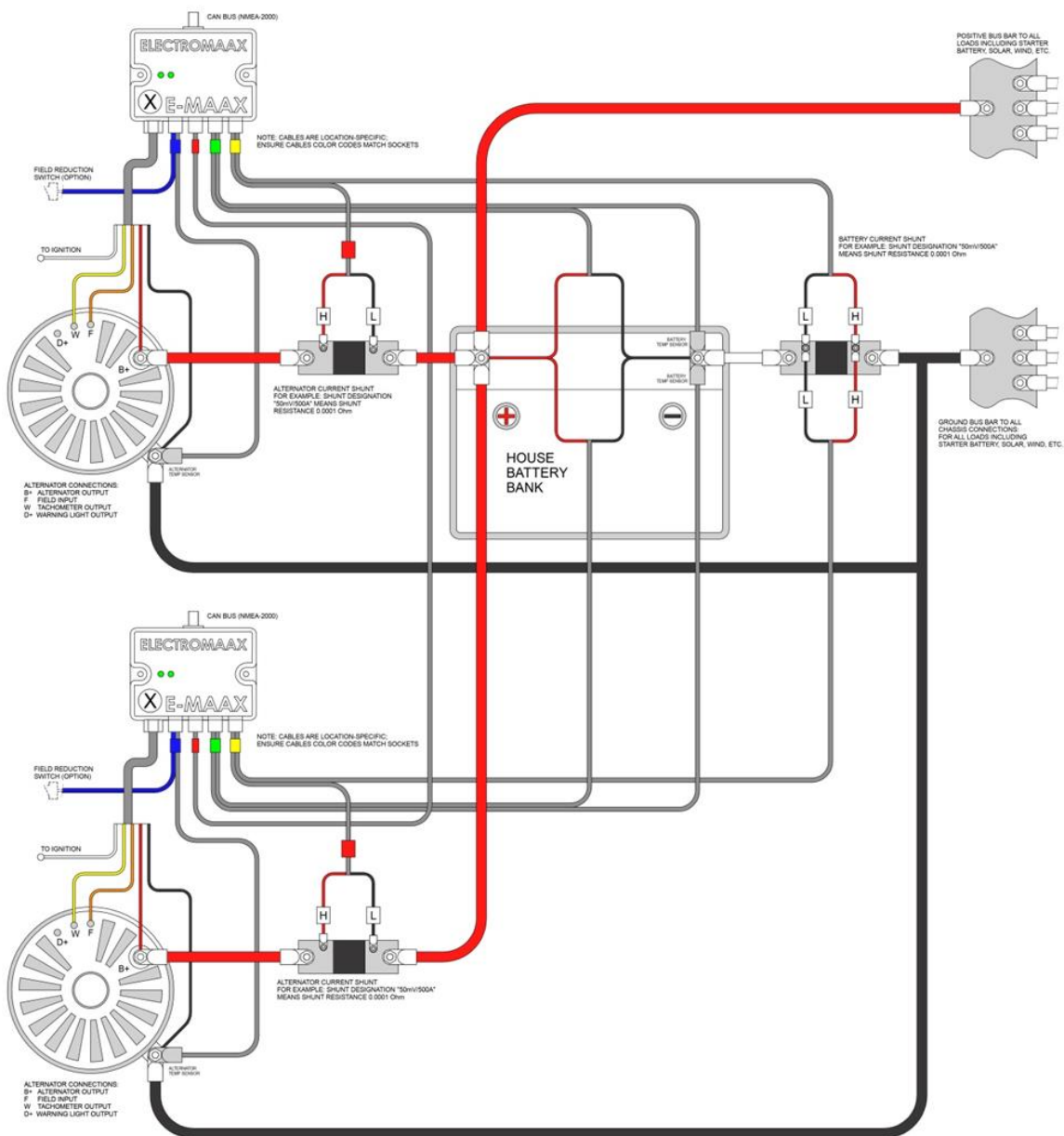

Single Engine (Showing 2nd Alternator option)

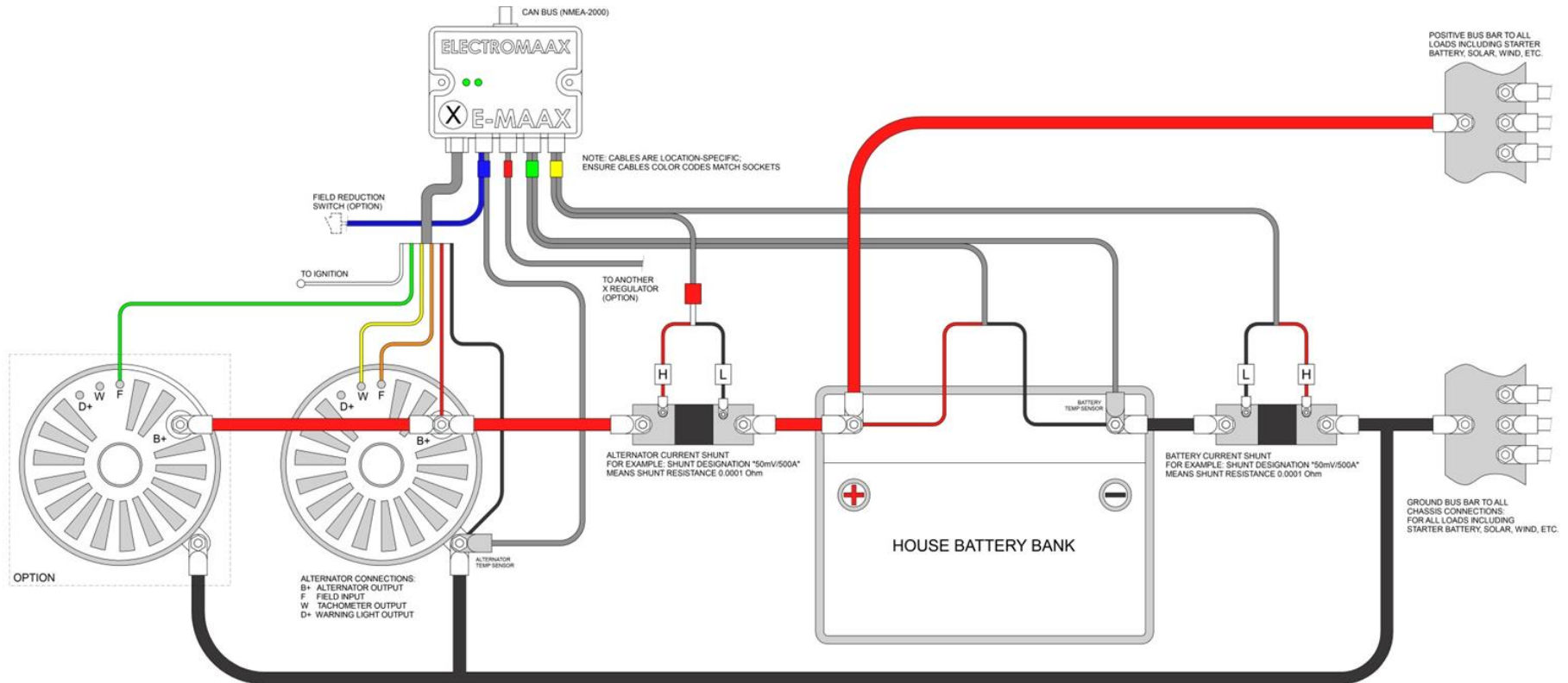

System with Remote Rectifier

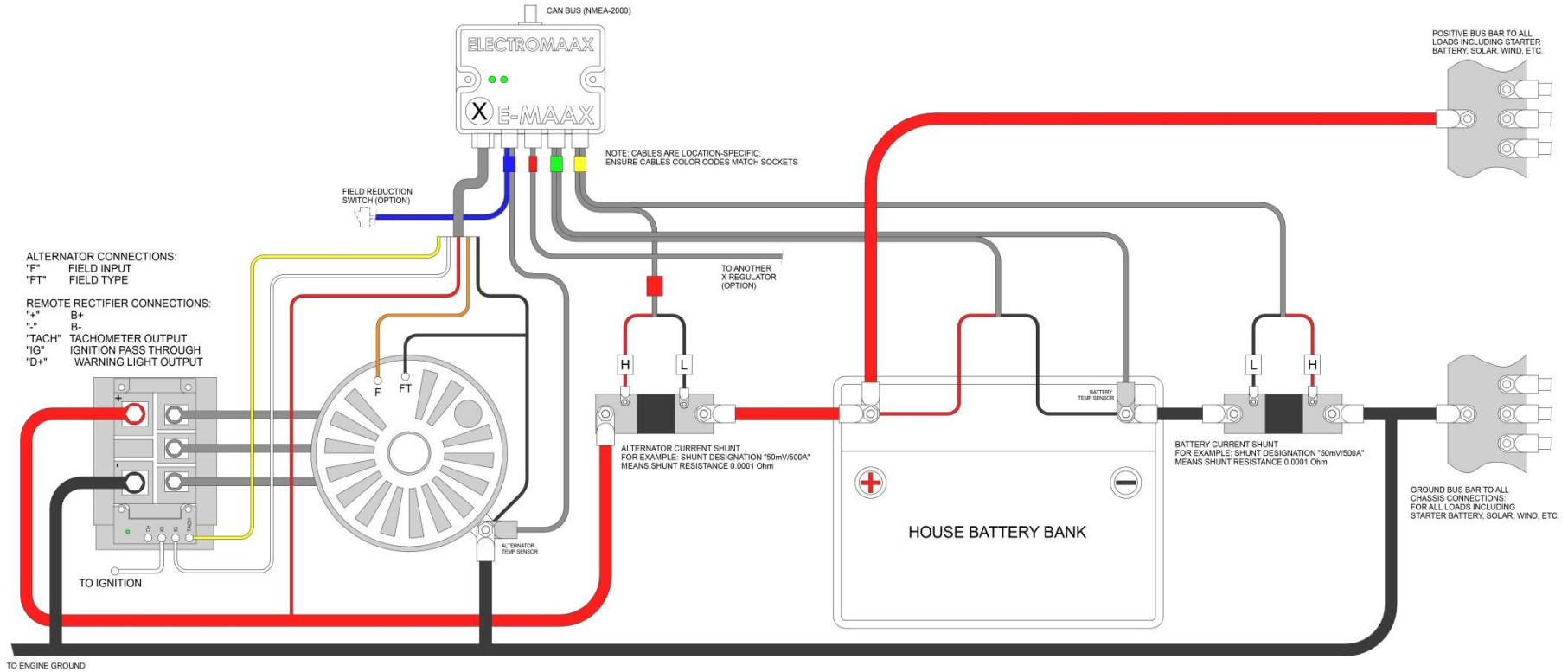

Notice

ElectroMaax reserves the right to make product modifications or discontinue products without notice. Customers are advised to obtain latest written specifications prior to ordering products. Information provided by ElectroMaax is believed to be accurate at the time of its release. Products sales are subject to the ElectroMaax Terms of Sales in force at the time of order acknowledgment. ElectroMaax products are not designed, authorized, or warranted for use in life support devices and systems, or any other critical applications which may involve death, injury, property or environmental damages. Using ElectroMaax products for any critical application is fully at the risk of the customers and their end users and assigns.